

# LINAX 4000M

## Continuous-line recorder

### Applications

The configurable continuous-line recorder LINAX 4000M serves to record slowly changing measured quantities. DC current, DC voltage, thermocouples as well as resistance thermometers (Pt 100) can be connected directly. Alphanumeric texts can be printed out on the recording chart. The recorder is meant for installation in panels.

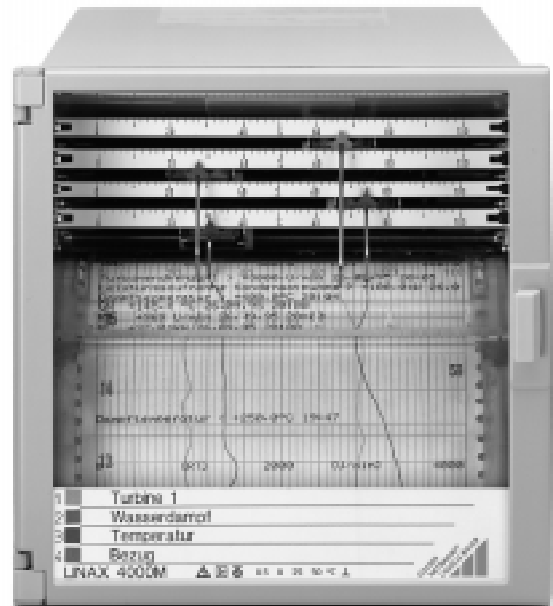

### Essential features

- 1 to 4 line channels
- 1 to 3 line channels and one printer channel for data recording and text printout
- Format 144 mm x 144 mm, mounting depth 250 mm
- Combined recording table for roll chart (32 m) or fanfold chart (16 m)
- RS-485 interface
- Measuring channels electrically isolated
- 2 limits per measuring channel

### Description

The LINAX 4000M is a microprocessor-controlled, continuous-line recorder. It is supplied in two different versions:

- 1 to 4 line channels
- 1 to 3 line channels and one printer channel

The recorder is connected to transducers and/or directly to sensors such as thermocouples or resistance thermometers.

Matching of the recorder to the task is made via the internal keyboard or via the serial interface.

Additional functions such as text printout and event markers increase the information content of the process quantities for which a protocol can be established. Alarm message and remote control make the LINAX 4000M a unit for versatile use.

# LINAX 4000M

## Continuous-line recorder

### Applied rules and standards

#### A) International standards

IEC 484	Potentiometric recorders
IEC 1010-1	Safety requirements for electrical equipment for measurement control and laboratory use
IEC 664	Overvoltage category, degree of pollution
IEC 68-2-6	Mechanical stress (vibrations)
IEC 68-2-27	Mechanical stress (shock)
IEC 529	Degrees of protection provided by enclosures
IEC 801, EN 60801	Immunity to interference of electromagnetic influences
EN 55011	Radio interference suppression
EN 61010	Safety requirements of measurement and control equipment
IEC 721-3-3	Climatic environmental conditions
IEC 742	Isolating transformers and safety isolating transformers – requirements

#### B) German standards

DIN 43802	Scales
DIN 16234	Recording paper
DIN 43831	Cases
DIN 43834	Device fasteners
DIN VDE 0551-1	Transformers and safety transformers
DIN VDE 0100-410	Protection against shock currents
DIN VDE 0106-101	Basis requirements for protective separation

### Symbols and their meaning

Symbol	Meaning
X1n / X1	Lower range limit nom. range / lower range limit
X2n / X2	Upper range limit nom. range / upper range limit
X2n – X1n / X2 – X1	Range span nom. range / range span

### Technical data

#### Analog inputs

##### Standard version

DC current	0...20 mA; Ri = 50 Ω 4...20 mA; Ri = 50 Ω ± 20 mA; Ri = 50 Ω
DC voltage	± 10 V; Ri = 1 MΩ

##### Universal version

DC current	0...20 mA; Ri = 50 Ω 4...20 mA; Ri = 50 Ω ± 20 mA; Ri = 50 Ω
DC voltage	± 20 V; Ri = 1 MΩ ± 75 mV; Ri ≥ 2 MΩ
Thermocouples, Ri ≥ 2 MΩ	Type T 0 ... +400 °C Type J 0 ... +1200 °C

Thermocouples, Ri ≥ 2 MΩ	Type L 0 ... +900 °C Type K 0 ... +1372 °C Type E 0 ... +1000 °C Type S 0 ... +1769 °C Type R 0 ... +1769 °C Type B 100 ... +1820 °C  Cold junction compensation internally or externally parameterizable
Resistance thermometer Pt 100	–50 ... +500 °C; –50 ... 150 °C
With 2-wire connection	Lead resistance 10 Ω max.
With 3-wire connection	Lead resistance 40 Ω max.

**Lower range limit** can be parameterized from X1n ... X1n + 0,8(X2n – X1n) and **range span** can be parameterized from 0,2(X2n – X1n) ... (X2n – X1n).

**Deadband** 0.25 % of range span

**Setting time** 2 s

**Attenuation of the meas. value** with low-pass filter of 1st order;

**Time constant** 0 ... 60 s/meas. chann., can be parameterized

**Root-extra. function** can be parameterized with DC current and DC voltage measuring ranges

#### Reference conditions

Ambient temperature	25 °C ± 1 K
Relative humidity	45 ... 75 %
Auxiliary voltage	Hn ± 2 %, nominal frequency ± 2 %
Mounting position	Front upright ± 2°
Warm-up time	30 min

#### Accuracy

Deviation for line channels acc. to IEC 483	Class 0.5 referred to range span
With displacement of lower range limit and/or upper range limit additionally	± (0.1 % × $\frac{X2n - X1n}{X2 - X1}$ – 0.1)
Data recording with printer system according to IEC 484	Class 1 referred to range span
With internal cold junction compensation	± 4 K, additionally

#### Variations

Temperature	0.2 %/10 K, additionally 0.1 %/10 K with connect. to thermocouple
Humidity	Note influence on recording paper according to DIN 16234
Auxiliary voltage Hn	0.1 % at 24 V AC/DC ± 20 % 0.1 % at 24 V AC +10 % / –15 % 0.1 % at 115 V AC +10 % / –15 % 0.1 % at 230 V AC +10 % / –15 %
AC interference voltages (see perm. interference voltages)	0.5 % of range span
Magnetic field of external origin 0.5 mT	0.5 % of range span
Mechanical stress according to DIN IEC 68-2-6/27	During and after the effect ± 0.5 % of range span
Transport	
in function	
Impact: 30 g/18 ms Vibration: 2 g/5 ... 150 Hz 0.5 g/± 0,04 mm/ 5...150 Hz/3 × 2 cycles	

# LINAX 4000M

## Continuous-line recorder

### Real-time clock

Function maintained in the case of power failure: 5 days (cond.)

### Options (code GA001)

#### Binary inputs

Number 4 (speed 2, speed off, DI 1, DI 2)  
 Auxiliary voltage DC 20 ... 24 ... 30 V  
 Input current 6 mA  
 H signal 20 ... 30 V  
 L signal 0 ... 1.3 V

#### Relay outputs

Four potential-free relay contacts (connected with each other on one side), contact load 30 V / 100 mA.

#### External speed change

It can be switched between speed 1 and 2 (terminals 901-922); the chart speed can be switched off (terminals 901-912).

#### Event markers

Only for version with printer channel  
 Two markers possible

Recording at approx. 2 % and 5 % of the recording width

#### Standby function

The standby function is activated via a freely selectable binary input.

#### Paper end signal

With speeds of  $\geq 120$  mm/h, 2 hours before the paper ends. With speeds smaller than  $< 120$  mm/h, at least 8 hours before the paper ends.

Signalling is effected via a freely correlatable relay contact.

Output: potential-free contact. When changing the recording paper the length of the chart roll must be entered into the recorder.

#### Limit monitoring

Two limits per channel for absolute monitoring.  
 The four internal relays can freely be correlated with the limits.  
 Hysteresis 2 % of range span.

### Display

#### Scale

One graduation per measuring system  
 Scale face 5 mm wide  
 Character size 2 mm

#### Control and display table (only for parameterizing)

Display  
 5-digit 7-segment display  
 Size of characters 4 x 7 mm  
 Operation via 3 keys



### Recording



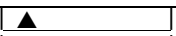
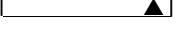

Arrangement of measuring systems and color correlation

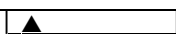

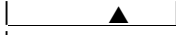
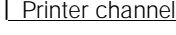

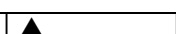
#### Version without printer channel

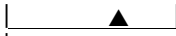
	1	2	3	4	No. of line channels
 green			x	x	
 red		x	x	x	
 blue	x	x	x	x	
 violet				x	

#### Version with printer channel

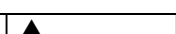
		2		No. of channels
 green				
 red				
 blue	x			
 Printer channel	x			

			3	No. of channels
 green				
 red			x	
 blue			x	
 Printer channel			x	

				4	No. of channels
 green				x	3rd channel
 red				x	2nd channel
 blue				x	1st channel
 Printer channel				x	4th channel

- Line recording  
 Fiber recording pen with inkwell of approximately 1.4 ml, line length approximately 1300 m, distance between the tips of the fiber recording pens 2 mm.
- Printing  
 A printer system for printing of texts can be installed in place of the lower measuring system. Distance between blue fiber pen and print head 6 mm.

In addition to the text printout, a measured value can be recorded with the printer system.  
 Recording of the measured value is made in the form of a dotted line with equidistant dot spacing.  
 Color supply of the print head approx.  $1.5 \times 10^6$  dots.

Text printout for:

- Eight text lines of 16 characters each.  
 Each text line is supplemented with time printout. Resolution cyclic, in parameterizable intervals or event-depending by internal limits or external stimulation (binary inputs).
- Printout of chart speed, date and time.  
 Initiation with recorder ON and with a change in chart speed.
- Printout of time and date.  
 Cyclic initiation, in parameterizable time intervals or event-depending by external stimulation.
- Printout of actual measured values  
 Cyclic initiation, in parameterizable time intervals or event-depending by internal/external stimulation.
- Printout of double lines correlated with the individual measuring points.  
 First line: Scaling line with channel designation and printout of the unit.  
 Second line: Text specific to the measuring point, max. 32 characters.
- Listing of all active parameters  
 Manual initiation in parameterizing mode.

# LINAX 4000M

## Continuous-line recorder

### Text printout/recording

Maximum possible chart speed with print channel instead of fibre-tip pen	240 mm/h
Size of characters	approx. 1.5 × 2 mm
Chart speed	2 chart speeds can be parameterized in mm/h: 0/2,5/5/10/20/60/120/240/300/600/1200 can be changed-over and disconnected externally (24 V DC/6 mA)
Recording chart	32 m roll chart or 16 m fanfold chart
Visible chart length	60 mm
Recording width	100 mm (chart width 120 mm, DIN 16230)
Chart intake (with roll chart)	Via automatic paper take-up device (daily tear-off or take-up of the 32 m possible)

### Auxiliary voltage

24 V AC/DC ± 20 % or  
24/115/230 V AC +10 %/-15 %  
Frequency range 47.5 ... 63 Hz  
Power consumption with max. fitting approx. 20 W/27 VA

### RS-485 interface (optionally RS-232 with adapter)

- For parameterizing
- Linking to host systems for bidirectional data transmission.  
Data protocol with reference to the PROFIBUS standard.

### Climatic suitability

Ambient temperature	0 ... 25 ... 50 °C
Transport and storage temperature	-40 ... +70 °C
Relative humidity	≤ 75 % annual average max. RH ≤ 85 % in function
Climatic class	3K3 acc. to IEC 721-3-3

### Electrical safety

Test according to DIN EN 61010-1 (classification VDE 0411) or IEC 1010-1  
Overvoltage category III at the power input and degree of pollution 2 according to VDE 0110, parts 1 and 2  
Test voltage  
3.75 kV measuring channels to energy supply  
2.20 kV protective conductor to energy supply

### Functional extra low voltage with protective separation (PELV)

Between power input – measuring channels, control leads, interface cables acc. to VDE 0100 part 410 and VDE 0106 part 101.

### Electromagnetic compatibility

The protection goals of the EMC directive 89/336/EWG as to radio interference suppression according to EN 55011 and as to immunity to interference according to EN 50082-2 are complied with.

#### Radio interference suppression

Limit class B according to EN 55011 or  
Post decree 243/92.

Immunity to interference: test according to IEC 801

Type of test	Test severity	Variation	Severity level
ESD (1/30 ns)	6 kV	≤ 1 %	3
HF field radiated 25 MHz ... 1 GHz	10 V/m	≤ 1 %	3
line-guided 0.15 ... 80 MHz	10 V/m	≤ 1 %	3
Burst (5/50 ns) on			
Power line	2 kV	≤ 1 %	3
Test lead	1 kV	≤ 1 %	3
Surge (1,2/50 μs) on			
Power line common	2 kV	≤ 1 %	3
differential	1 kV	≤ 1 %	2
1 MHz pulse on			
Power line common	2 kV	≤ 1 %	3
differential	1 kV	≤ 1 %	3

The NAMUR industry standard EMC is met (Interface cables shielded).

#### Permissible interference voltages

Permissible interference	Standard version	Universal version voltage
Series mode interf. voltage Peak-peak	≤ 0.3 × meas. span max. 3 V	≤ 3 × meas. span max. 3 V
Push-pull rejection	35 dB	35 dB
Common mode interference voltage	60 V DC/42 V AC	60 V DC/42 V AC
Common mode rejection	70 dB	70 dB

# LINAX 4000M

## Continuous-line recorder

### Default parameter setting

If individual parameter setting is not specified when ordering a recorder, the LINAX 4000M is delivered with the following default parameter setting:

All measuring channels with 0...20 mA measuring range

Chart speed 1: 20 mm/h

Chart speed 2: 120 mm/h

Chart speed 3: Off

Limits are set to end positions (0 and 20 mA).

Attenuation of measured value, zoom, printer and limit functions are inactive. No password entered.

This default parameter setting can be re-initialized independent of the actually set parameters

### Scope of delivery

1 copy of operating instructions

2 fasteners

1 chart roll or fanfold pack, inserted in the unit

1 fiber recording pen per measuring channel

1 print inset (for recorder version with printer channel)

Additionally, depending upon the order:

Centering angle bracket for installation in mechanical grids;  
reading ruler(s)

### Example of interlinking

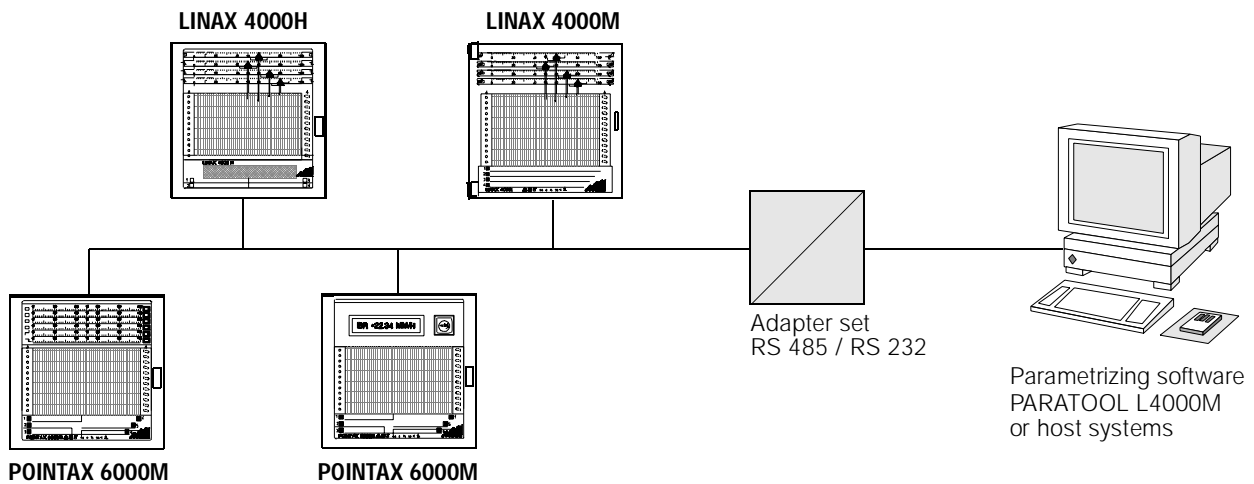

# LINAX 4000M

## Continuous-line recorder

### Connection, case and installation

#### Electrical connections

- Protection type IP 20
- Screw and plug terminals for signal inputs, control inputs and limit relay outputs.
- Max. wire cross section 2 x 1 mm<sup>2</sup>
- Screw terminals for line connection
- Max. wire cross section 4 mm<sup>2</sup>
- RS-485 interface via 9-pin SUB-D plug

#### Case

- Molded material for installation in panels or mechanical grids (see dimensional drawing for dimensions)

#### Protection type of case (including front)

- IP 54 according to DIN 40050

#### Color of case

- Silica-gray according to RAL 7032

#### Front door

- Molded material (RAL 7032) with mineral glass or plastics

#### Fastening of case

- With 2 fasteners (optionally for installation in panel or mechanical grid), centering angle brackets are required for installation in mechanical grids, see BA No. 605

#### Position of use

- Lateral [-30° ... 0 ... +30°], inclined to the rear 20°, to the front 20°

#### Mounting distance

- Horizontal or vertical 0 mm, it must be possible to open the door of the case through 100°
- Weight 3.2 kg, approx.

#### Dimensional drawing (dimensions in mm)

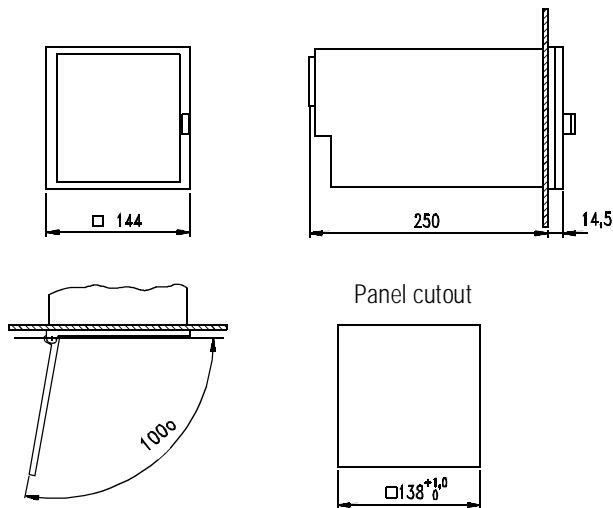

### Wiring diagrams

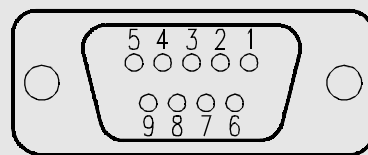
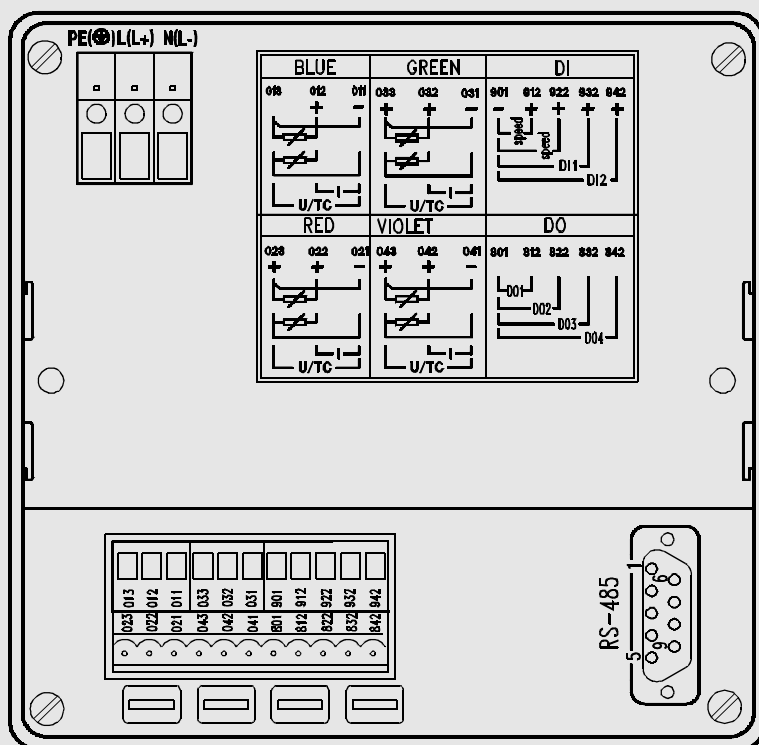

#### RS 485 interface

- Pin 1: Shield
- Pin 3: RXD (+)
- Pin 5: Gnd (reference potential)
- Pin 6: +5 V
- Pin 8: RXD (-)

#### For bus operation:

- The + 5 V voltage on pin 6 is required when the LINAX 4000M is used as bus termination device.

- The shield is attached to a plug connector on the recorder case.

Speed circuitry (terminals 901, 912, 922)  
Binary inputs =  
depending upon parameter setting  
for event markers - initiation of text printout  
(terminals 901, 932, 942)

#### Signal inputs

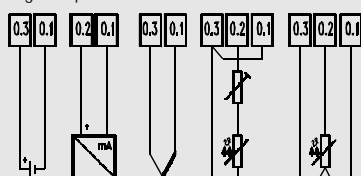

#### Limit contacts

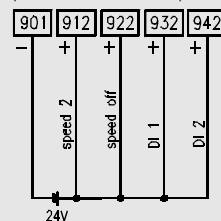
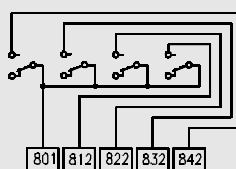

# LINAX 4000M

## Continuous-line recorder

### Order code

Description		Ident number	
Continuous-line recorder LINAX 4000M in standard version with identical DC measuring ranges for all channels		A4001	
Front dimensions 144 × 144mm			
Continuous-line recorder LINAX 4000M with universal card and basic parameter setting according to data sheet, measuring range 0 ... 20 mA		A4002	
Front dimensions 144 × 144mm			
Continuous-line recorder LINAX 4000M with universal card and parameter setting as per request			A4003
Front dimensions 144 × 144mm			
	1 line channel	AA001	
	2 line channels	AA002	
	3 line channels	AA003	
	4 line channels	AA004	
	1 line channel plus print channel	AA005	
	2 line channels plus print channel	AA006	
	3 line channels plus print channel	AA007	
	1 line channel	AA001	AA001
	2 line channels	AA002	AA002
	3 line channels	AA003	AA003
	4 line channels	AA004	AA004
	1 line channel plus print channel	AA005	AA005
	2 line channels plus print channel	AA006	AA006
	3 line channels plus print channel	AA007	AA007
Parameter setting			
Parameter presetting (for ident no. A4001)		see page 5	BA000
Deviating parameter setting according to data sheet (for ident no. A4001)			BA900
Meas. range (all channels identical)			
Binary inputs and limits		only with GA001	
Text lines, time and date, scaling line, ...		only with AA005,AA006,AA007	

Cont'd on next page

# LINAX 4000M

## Continuous-line recorder

### Order code (cont'd)

Description			Ident number		
Lower range limit	nom. range X1n				
Upper range limit	nom. range X2n				
<b>Meas. ranges for ident no. A4003</b>			<b>Lower range limit X1</b>	<b>Upper range limit X2</b>	
<b>Meas. range 1st channel:</b>					
DC current	X1n	X2n			
	0 mA	20 mA	0.0 mA ≤ X1 ≤ 16.0 mA	X1 + 4.0 mA ≤ X2 ≤ 20 mA	BA001
	4 mA	20 mA	4.0 mA ≤ X1 ≤ 16.8 mA	X1 + 3.2 mA ≤ X2 ≤ 20 mA	BA002
	-20 mA	20 mA	-20.0 mA ≤ X1 ≤ 12.0 mA	X1 + 8.0 mA ≤ X2 ≤ 20 mA	BA003
DC voltage	X1n	X2n			
	-20 V	+20 V	X1 = -20 V -20 V ≤ X1 ≤ 12 V X1 = -75 mV	X2 = 20 V X1 + 8 V ≤ X2 ≤ 20 V X2 = 75 mV	BA004 BA914 BA005
Resist. thermometer	X1n	X2n			
2-wire	-50 °C	+500 °C	-50 °C ≤ X1 ≤ 390 °C	X1 + 110 °C ≤ X2 ≤ 500 °C	BA901
2-wire	-50 °C	+150 °C	-50 °C ≤ X1 ≤ 110 °C	X1 + 40 °C ≤ X2 ≤ 150 °C	BA902
3-wire	-50 °C	+500 °C	-50 °C ≤ X1 ≤ 390 °C	X1 + 110 °C ≤ X2 ≤ 500 °C	BA903
3-wire	-50 °C	+150 °C	-50 °C ≤ X1 ≤ 110 °C	X1 + 40 °C ≤ X2 ≤ 150 °C	BA904
Thermocouple	X1n	X2n			
Type T	0 °C	400 °C	0 °C ≤ X1 ≤ 320 °C	X1 + 80 °C ≤ X2 ≤ 400 °C	BA905
Type J	0 °C	1200 °C	0 °C ≤ X1 ≤ 960 °C	X1 + 240 °C ≤ X2 ≤ 1200 °C	BA906
Type L	0 °C	900 °C	0 °C ≤ X1 ≤ 720 °C	X1 + 180 °C ≤ X2 ≤ 900 °C	BA907
Type K	0 °C	1372 °C	0 °C ≤ X1 ≤ 1097 °C	X1 + 275 °C ≤ X2 ≤ 1372 °C	BA908
Type E	0 °C	1000 °C	0 °C ≤ X1 ≤ 800 °C	X1 + 200 °C ≤ X2 ≤ 1000 °C	BA909
Type S	0 °C	1769 °C	0 °C ≤ X1 ≤ 1415 °C	X1 + 354 °C ≤ X2 ≤ 1769 °C	BA910
Type R	0 °C	1769 °C	0 °C ≤ X1 ≤ 1415 °C	X1 + 354 °C ≤ X2 ≤ 1769 °C	BA911
Type B	100 °C	1820 °C	100 °C ≤ X1 ≤ 1476 °C	X1 + 344 °C ≤ X2 ≤ 1820 °C	BA912
<b>Scale 1st channel:</b>			Same as measuring range		BB001
			Without graduation	BB002	BB002
			0 ... 100	BB003	BB003
			as per request	BB900	BB900
<b>Reading ruler 1st channel:</b>			Without reading ruler	BC000	BC000
			Same as scale	BC001	BC001
			0 ... 100	BC002	BC002
			as per request	BC900	BC900

Cont'd on next page



# LINAX 4000M

## Continuous-line recorder

### Order code (cont'd)

Description			Ident number		
<b>Measuring range 2nd channel</b> , only for 2-channel or multi-channel versions:					
Same as measuring range 1st channel, but markings CA...					CAxxx
<b>Scale 2nd channel</b> , only for 2-channel or multi-channel versions:					
Same as scale 1st channel, but markings CB...			CBxxx	CBxxx	CBxxx
<b>Reading ruler 2nd channel</b> , only for 2-channel or multi-channel versions:					
Same as 1st channel, but markings CC...			CCxxx	CCxxx	CCxxx
<b>Measuring range 3rd channel</b> , only for 3-channel or four-channel version:					
Same as measuring range 1st channel, but markings DA...					DAxxx
<b>Scale 3rd channel</b> , only for 3-channel or four-channel version:					
Same as scale 1st channel, but markings DB...			DBxxx	DBxxx	DBxxx
<b>Reading ruler 3rd channel</b> , only for 3-channel or four-channel version:					
Same as 1st channel, but markings DC...			DCxxx	DCxxx	DCxxx
<b>Measuring range 4th channel</b> , only for four-channel version:					
Same as measuring range 1st channel, but markings EA...					EAxxx
<b>Scale 4th channel</b> , only for four-channel version:					
Same as scale 1st channel, but markings EB...			EBxxx	EBxxx	EBxxx
<b>Reading ruler 4th channel</b> , only for four-channel version:					
Same as 1st channel, but markings EC...			ECxxx	ECxxx	ECxxx
<b>Options</b> (binary input, limits) see page 3			No	GA000	GA000
			Yes	GA001	GA001
Further parameters same as <b>parameter presettings</b> see page 5					HA000
Further <b>parameters deviating</b> from the parameter presetting					HA900
Recording type					
for roll (32 m)			KA001	KA001	KA001
for fanfold pack (16 m)			KA002	KA002	KA002
Auxiliary voltage:					
AC: 21 V ... <u>24 V</u> ... 26 V			LA001	LA001	LA001
AC: 98 V ... 115 V ... 126 V			LA002	LA002	LA002
AC: 196 V ... <u>230 V</u> ... 253 V			LA003	LA003	LA003
AC/DC: 20 V ... <u>24 V</u> ... 28 V			LA004	LA004	LA004
Front door:					
Plastic			MA001	MA001	MA001
Metal			MA002	MA002	MA002
Label:					
Blank, with GOSSEN- METRAWATT logo			NA000	NA000	NA000
Blank, without logo			NA001	NA001	NA001
With inscr. as per request, 1 line/meas. point with max. 31 charact.			NA900	NA900	NA900
Test protocol					
No			PA000	PA000	PA000
With factory certificate according to DIN 50049			PA001	PA001	PA001

Cont'd on next page

# LINAX 4000M

## Continuous-line recorder

### Order code (cont'd)

Description			Ident number		
Operating instructions	German		RA000	RA000	RA000
	No		RA001	RA001	RA001
	English		RA002	RA002	RA002
	French		RA003	RA003	RA003
	Italian		RA004	RA004	RA004

### Accessories

Ident numbers ending with a letter are complete and need not be commented.  
Ident numbers ending with a numeral must be commented with the following markings.

Description			Ident-Nummer		
PARATOOL L4000M		A402C			
Parameterizing software for LINAX 4000M					
RS 485 / RS 232 adapter set		A403A			
incl. power supply and connection cable, 3 m, with plugs on both ends and 9-pin / 25-pin adapter plug					
Scale without graduation, beginning and end marked		A410A			
Scale, graduation as per request			A4130		
Graduation:			AA900		
Reading ruler, graduation as per request			A4120		
Graduation:			AA900		
Label for measuring point			A4110		
With GOSSEN-METRAWATT logo			AA000		
Without GOSSEN-METRAWATT logo			AA001		
Channel green without inscription			BA001		
Channel green with inscription			BA900		
Channel red without inscription			BB001		
Channel red with inscription			BB900		
Channel blue without inscription			BC001		
Channel blue with inscription			BC900		
Channel violet without inscription			BD001		
Channel violet with inscription			BD900		
Screw terminal with five connectors			A404A		
Screw terminal with three connectors				A404B	
4 each centering angle (wit installation in grid)				A416A	
Bus termination resistors					A409A
Package of 2 × 390 Ohm and 1 × 150 Ohm					

# LINAX 4000M

## Continuous-line recorder

### Consumable items

Ident numbers ending with a letter are complete and need not be commented.  
Ident numbers ending with a numeral must be commented with the following markings.

Description			Ident number					
Recording chart, chart width 120 mm, recording width 100 mm								
Chart roll 32 m, graduation 0 ... 100, minimum ordering quantity 25 rolls								
	Time graduation / speed	None	A401A					
		10 mm/h	A401B					
		20 mm/h	A401C					
		60 mm/h	A401D					
		120 mm/h	A401E					
Chart roll 32 m, graduation 0 ... 100, minimum ordering quantity 25 rolls			A4070					
	Time graduation / speed	as per request	CA900					
Chart roll 32 m, with calibrated graduation, minimum ordering quantity 25 rolls			A4071					
	Calibrated graduation	as per request	AA900					
	Inscription	as per request	BA900					
	Time graduation / speed	as per request	CA900					
Fanfold pack 16 m, graduation 0 ... 100, minimum ordering quantity 25 packs								
	Time graduation / speed	ohne				A401L		
		10 mm/h				A401M		
		20 mm/h				A401N		
		60 mm/h				A401P		
		120 mm/h				A401Q		
Fanfold pack 16 m, graduation 0 ... 100, minimum ordering quantity 25 packs						A4075		
	Time graduation / speed	as per request				AA900		
Fanfold pack 16 m, with calibrated graduation, minimum ordering quantity 25 packs						A4074		
	Calibrated graduation	as per request				AA900		
	Inscription	as per request				BA900		
	Time graduation / speed	as per request				CA900		
Recording styli / printer styli								
Stylus green								A406B
Stylus red								A406A
Stylus blue								A406C
Stylus violet								A406D
Printer stylus violet								A406E

# LINAX 4000M

## Continuous-line recorder

---

Printed in Germany • Subject to change without notice • 6/11.97 Ordering no. 3-348-794-03

GOSSEN-METRAWATT GMBH  
D-90327 Nürnberg

Company address:  
Thomas-Mann-Straße 16-20  
D-90471 Nürnberg  
Telefon +49 911 8602-0  
Telefax +49 911 8602-669

GOSSEN  
METRAWATT  
CAMILLE BAUER

